

# Level sensing relative and absolute pressure transmitter type 712

Pressure range  
0 ... 0.3 - 3 bar



The level sensing pressure transmitter Type 712 is manufactured using an relative or absolute pressure measuring cell with an adjusted and amplified sensor signal and is available with various cable lengths from 2 to 30 meters. The Type 712 offers Ex protection as well as versions with integrated temperature measurement.

In addition to voltage and current outputs the Type 712 is available with ratiometric outputs.

- suitable for drinking water
- intrinsically safe execution with voltage- and current output
- suitable for fitting in 1-inch pipe
- with integrated temperature measurement

## Technical overview

### Pressure range

Relative	0.0 ... 0.3 – 2.5 bar
Absolute	0.8 ... 1.4 – 3.0 bar

### Operating conditions

Medium	Fuel oil, ultra-light <sup>1)</sup>	SN 181 160-2
	Fuel oil, heavy <sup>1)</sup>	SN 181 160-2
	Diesel oil <sup>1)</sup>	
	Benzine <sup>1)</sup>	
	Drinking water (with EPDM O-ring)	
Temperature	Medium and ambient <sup>2)</sup>	-20 ... +80 °C
	Storage	-40 ... +80 °C
Overload		3x fs; max. 3 bar at 0.3 bar version

### Materials in contact with medium

Case	Stainless steel 1.4404 / AISI 316L
Sensor	Ceramic Al <sub>2</sub> O <sub>3</sub>
Cable	PE-HD
Protection cover	PPE
Sealing material	FPM, EPDM (for drinking water)

### Electrical overview

	Output	Power supply	Load	Current consumption
2 wire	4 ... 20 mA	10 ... 30 VDC	$< \frac{\text{Power supply} - 7 \text{ V}}{0.02 \text{ A}}$ [Ohm]	< 20 mA
3 wire	0 ... 10 V	12 ... 30 VDC	> 10 kOhm / < 100 nF	< 5 mA
4 wire (with temperature)	ratim. 10 ... 90%	5 VDC ±10%	> 5 kOhm / < 100 nF	< 3 mA
4 wire (with temperature)	ratim. 10 ... 90%	5 VDC ±10%	> 5 kOhm / < 100 nF	< 3 mA
Polarity reversal protection	Short circuit proof and protected against polarity reversal.			
Overvoltage protection	4 ... 20 mA / 0 ... 10 V			36 VDC
	ratim. 10 ... 90 %			6 VDC
Electric strength towards case				500 VDC
Temperature output				> 1 MOhm

### Dynamic response

Response time	< 2 ms
---------------	--------

### Runtime

Time starts at the moment of application of minimal supply voltage	< 10 ms
--	---------

### Electrical connection

Cable PE-HD length 2, 5, 10, 15, 20, 30 m	Protection standard
---	---------------------

	IP 68
--	-------

### Test / Admissions

Electromagnetic compatibility	CE-conform acc. to EN 61326-2-3
UL	ANSI/UL 61010-1 acc. to E325110
Drinking water approval	ACS
	UBA guidance (KTW and elastomer)
Drinking water verification certificate for plastic parts	W270
	WRAS

### Ex-protection

IECEX SEV 12.0006	Ex ia IIC T4 Ga
SEV 12 ATEX 0138	II 1 G Ex ia IIC T4 Ga

### Weight

Without cable	~ 200 g
---------------	---------

### Packaging

Single packaging	
------------------	--

## Accuracy

### Standard

Parameter	Unit	
Max. deviation <sup>3)</sup> at 25 °C	% fs	± 0.8
Resolution <sup>4)</sup>	% fs	0.1
Thermal characteristic <sup>5), 6)</sup>	% fs/10K	± 0.2
Long term stability acc. IEC EN 60770-1 max.	% fs	± 0.25

Higher accuracy (only with ratiometric execution and pressure range ≥ 1 bar)

Parameter	Unit	
Max. deviation at compensated temperature range <sup>3)</sup> at -10 ... +60 °C	% fs	± 0.5
Resolution	% fs	0.1
Long term stability acc. IEC EN 60770-1 max.	% fs	± 0.25

<sup>1)</sup> Ex-protection to attention!  
<sup>4)</sup> pressure range 0.3 bar < 0.2 % fs

<sup>2)</sup> non-congealing media  
<sup>5)</sup> at -20 ... +80 °C

<sup>3)</sup> incl. zero point, full scale, linearity, hysteresis and repeatability  
<sup>6)</sup> 0.3 bar-type with output 4 ... 20 mA = ±0.5% fs/10K

Order code selection table				1	2	3	4	5	6	7	8	9	10		
				712. X X X X X X X X X X											
Pressure mode	Absolute			8											
	Relative			9											
	Absolute with higher accuracy			C				1,2							
	Relative with higher accuracy			D				1,2							
Pressure range <sup>1)</sup>	0.0 ... 0.3 bar	relative pressure	Pmax. 4.5 bar	9	1	3									
	0.0 ... 1.0 bar	relative pressure	4.5 bar	9,D	1	1									
	0.0 ... 1.6 bar	relative pressure	6.0 bar	9,D	1	2									
	0.0 ... 2.5 bar	relative pressure	9.0 bar	9,D	1	4									
	Max measurable level (for water depending on the locations weather)														
	0.8 ... 1.4 bar	absolute pressure	4.5 bar	3.5 ... 6.7 mWs	8	1	1								
	0.8 ... 2.0 bar	absolute pressure	6.0 bar	9.6 ... 12.8 mWs	8,C	1	2								
0.8 ... 3.0 bar	absolute pressure	9.0 bar	20.0 ... 23.0 mWs	8,C	1	4									
▲ Full scale signal at these pressures    ①    ② ① P <sub>BARO</sub> = 1060 mbar (high pressure on sea level) ② P <sub>BARO</sub> = 740 mbar (low pressure at 2000 meters above sea level)															
Sealing material	FPM	Fluoro-elastomer						0							
	EPDM	Ethylene propylene (for drinking water)						1							
Output / power supply	4 ... 20 mA	10 ... 30 VDC						0							
	ration. 10 ... 90%	5 VDC ±10%						1							
	ration. 10 ... 90%	5 VDC ±10% (with temperature)						2							
	0 ... 10 V	12 ... 30 VDC						3					0		
Electrical connection <sup>2)</sup>	Cable	2 m							0						
		5 m						1							
		10 m						2							
		15 m						3							
		20 m						4							
30 m						5									
Protection cover	without protection cover										2	0			
	with protection cover										2	1			
Ex-protection	without ex-protection												0		
	with ex-protection												4		
Pressure range variation (optional)	Indicate W and state range on order (e.g.: W0... + 2bar/OUT0...10V)													W	

### Dimensions in mm / Electrical connections

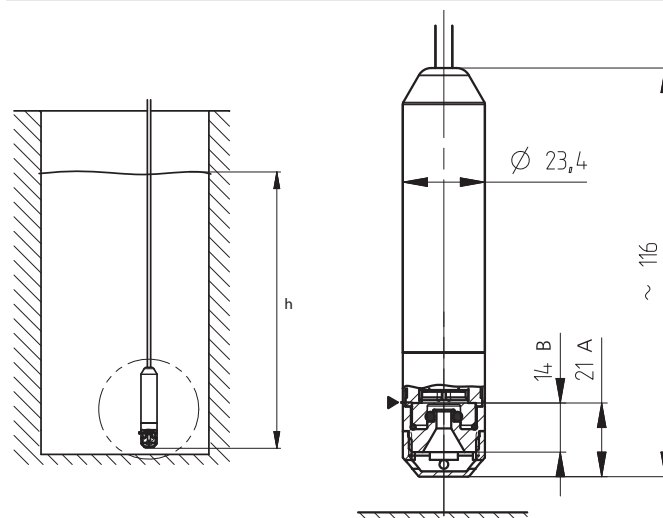

- h - Fluid level
- - Measurement reference height
- A - Distance from protection cover to the position of measuring diaphragm
- B - distance from beginning of thread to the position of measuring diaphragm (versions without protection cover)

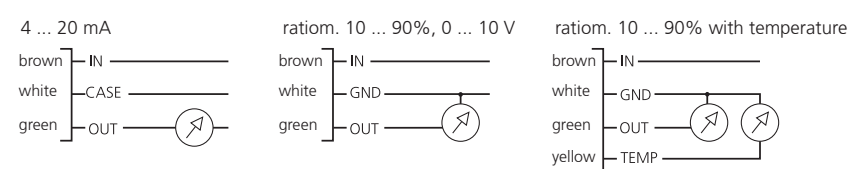

**Device design with explosion protection: 4 ... 20 mA**  
The grounding connection is conductively connected to the level transmitter housing. The ground conductor of level transmitter must be connected to the equipotential bonding system of the plant.

**Device design with explosion protection: ratiom. 10 ... 90%**  
The electronic GND is connected with a 1MΩ resistor to the level transmitter housing. The GND conductor of level transmitter must be connected to the equipotential bonding system of the plant.

<sup>1)</sup> Other pressure range on request      <sup>2)</sup> Other cable length on request

Accessories	Order number
Cable hanger	118026
Connection box	118027
Test adapter	118028
Protection cover (pack of 10)	118067
Humidity protection element (pack of 10)	118068
Additional weight	118093
Calibration certificate	104551

Connection box

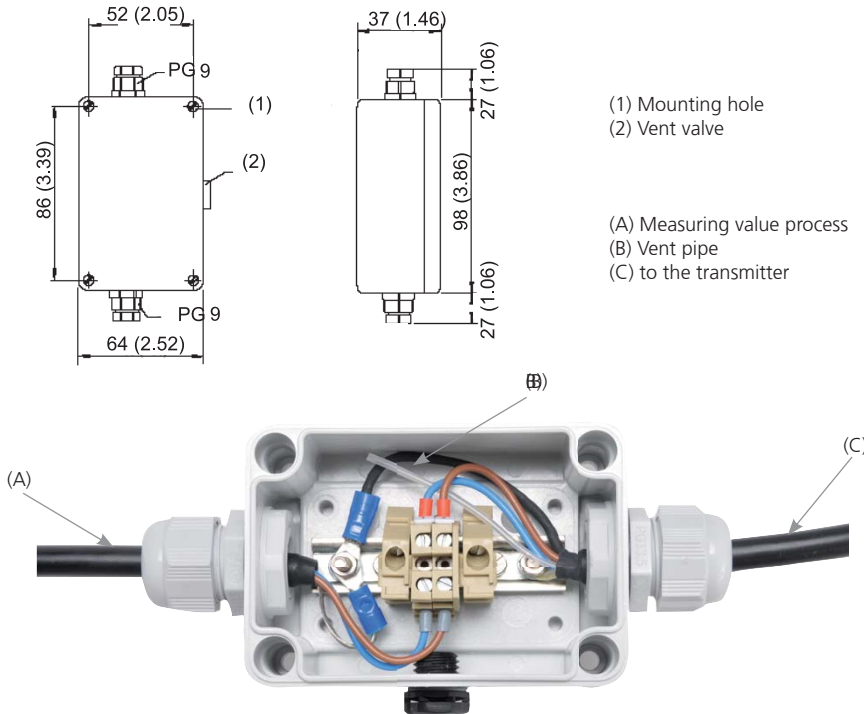

Additional weight

~200 g

Protection cover

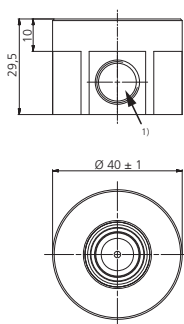

Cable hanger

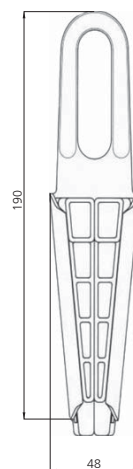

hot-dip galvanized steel –  
PA6 glass fibre reinforced

Cable  $\varnothing$  4.5 ... 6.5

## Calculation of level

General level with relative pressure sensor: 
$$h = \frac{\Delta p}{\rho \cdot g}$$

General level with absolute pressure sensor: 
$$h = \frac{P_{TS} - P_{Baro}}{\rho \cdot g}$$

which 
$$P_{TS} = \frac{U_{TS} - U_{TS\_NP}}{U_{TS\_EW} - U_{TS\_NP}} \cdot (P_{TS\_EW} - P_{TS\_NP}) + P_{TS\_NP}$$

and 
$$P_{Baro} = \frac{U_{Baro} - U_{Baro\_NP}}{U_{Baro\_EW} - U_{Baro\_NP}} \cdot (P_{Baro\_EW} - P_{Baro\_NP}) + P_{Baro\_NP}$$
 Using a second level sensor as barometric air pressure sensor

For level sensor with current output use nominal signal values for  $I_{TS}$  ... instead of variables  $U_{TS}$  ... (resp.  $I_{Baro}$  ... instead of  $U_{Baro}$  ...)

Simplification of formula for level sensor with ratiometric output:

$$P_{TS} = \frac{U_{TS} - 0.1 \cdot U_{IN}}{0.8 \cdot U_{IN}} \cdot (P_{TS\_EW} - P_{TS\_NP}) + P_{TS\_NP}$$

$$P_{Baro} = \frac{U_{Baro} - 0.1 \cdot U_{IN}}{0.8 \cdot U_{IN}} \cdot (P_{Baro\_EW} - P_{Baro\_NP}) + P_{Baro\_NP}$$
 Using a second level sensor as barometric air pressure sensor

Legend:

h	level [m]	$\rho$	density of media [kg/m <sup>3</sup> ]
		g	acceleration of fall 9.80665 [m/s <sup>2</sup> ]
$\Delta p$	measured relative pressure [Pa]	$U_{TS}$	signal on level sensor output [V or mA]
$P_{TS}$	measured pressure of level sensor [Pa]	$U_{Baro}$	Signal on barometer output [V or mA]
$P_{Baro}$	measured pressure of barometer [Pa]		
$P_{TS\_NP}$	minimal nominal pressure of level sensor [Pa]	$U_{TS\_NP}$	minimal nominal signal of level sensor [V or mA]
$P_{TS\_EW}$	maximum nominal pressure of level sensor [Pa]	$U_{TS\_EW}$	maximum nominal signal of level sensor [V or mA]
$P_{Baro\_NP}$	minimal nominal pressure of barometer [Pa]	$U_{Baro\_NP}$	minimal nominal signal of barometer [V or mA]
$P_{Baro\_EW}$	maximum nominal pressure of barometer [Pa]	$U_{Baro\_EW}$	maximum nominal signal of barometer [V or mA]

## Specification temperature output

$$T_{TEMP} = T_0 + 1 \left/ \left( a + b \cdot \ln \left( R \cdot \left[ \frac{U_{IN}}{OUT T} - 1 \right] \right) + c \cdot \ln \left( R \cdot \left[ \frac{U_{IN}}{OUT T} - 1 \right] \right)^3 \right) \right. T_{TEMP}$$

Temperature NTC [°C]  
-273.15 [°C]

OUT T Voltage NTC [V]  
R 20'000 [Ω]  
 $U_{IN}$  4.5 ... 5.5 [V]

a = 0.001204001  
b = 0.000208775  
c = 0.000000294

$T_{TEMP} = f(OUT T)$

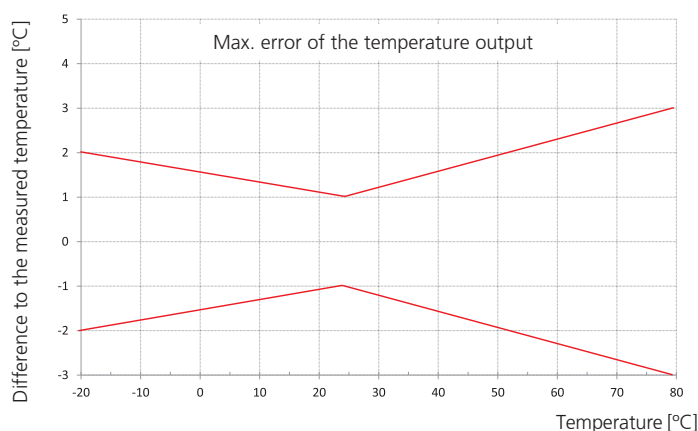
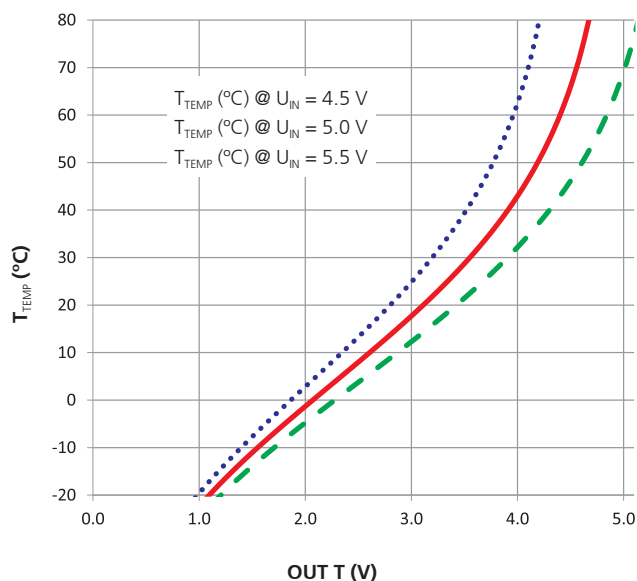

### Huba Control AG

#### Headquarters

Industriestrasse 17  
5436 Würenlos  
Telefon +41 (0) 56 436 82 00  
Telefax +41 (0) 56 436 82 82  
info.ch@hubacontrol.com

### Huba Control AG

#### Niederlassung Deutschland

Schlattgrabenstrasse 24  
72141 Walddorfhäslach  
Telefon +49 (0) 7127 23 93 00  
Telefax +49 (0) 7127 23 93 20  
info.de@hubacontrol.com

### Huba Control SA

#### Succursale France

Rue Lavoisier  
Technopôle Forbach-Sud  
57602 Forbach Cedex  
Téléphone +33 (0) 387 847 300  
Télécopieur +33 (0) 387 847 301  
info.fr@hubacontrol.com

### Huba Control AG

#### Vestiging Nederland

Hamseweg 20A  
3828 AD Hoogland  
Telefoon +31 (0) 33 433 03 66  
Telefax +31 (0) 33 433 03 77  
info.nl@hubacontrol.com

### Huba Control AG

#### Branch Office United Kingdom

Unit 13 Berkshire House  
County Park Business Centre  
Shrivenham Road  
Swindon Wiltshire SN1 2NR  
Phone +44 (0) 1993 776667  
Fax +44 (0) 1993 776671  
info.uk@hubacontrol.com